

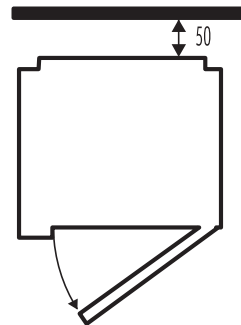

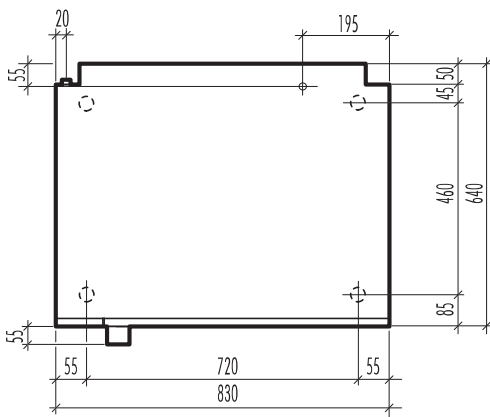

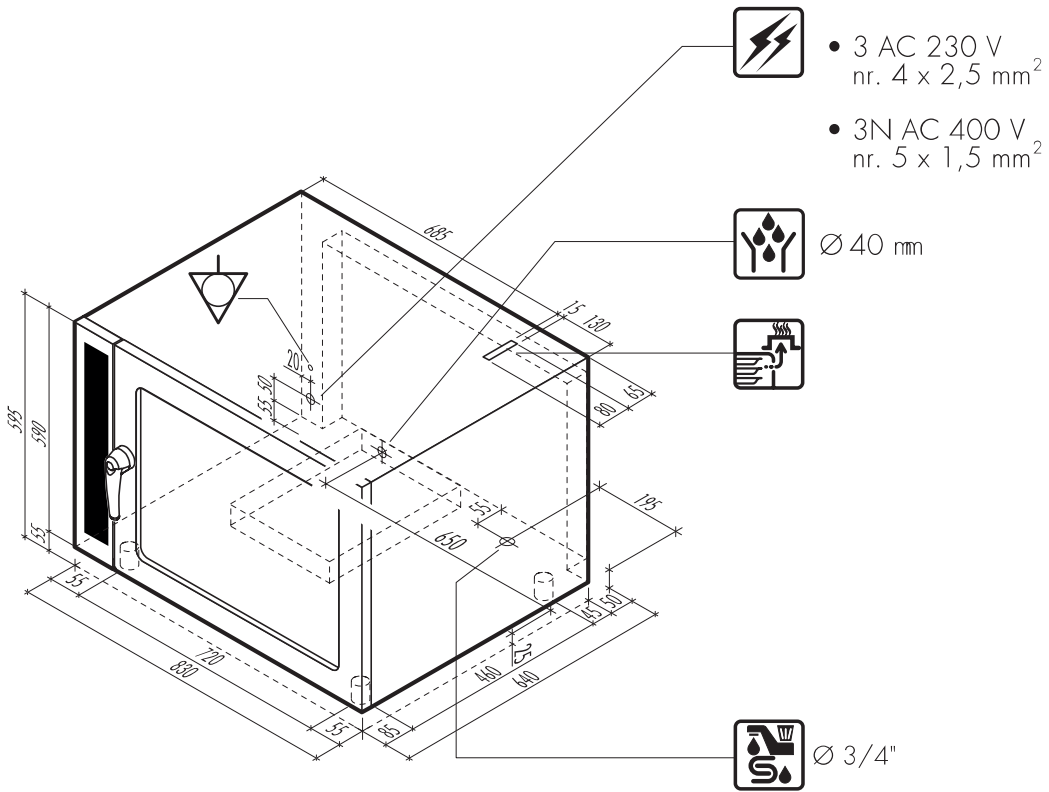







REC 051 M



Gemäss CE - Gasverordnung, soll für jedes Gerät eine angemessene Abgasabführung (Typ B13, B23, A3) vorbereitet werden

CE IPX 3

Anschluß Stromkabel 	Einfüllstutzen Dampfgenerator-Entkalker 	Luftansaugung 	Ablauf Flüssigkeiten 
Gaszufuhr und Gewindeart 	Dampfabführung und Garraum-Unterdrucksicherung 	Wasseranschluß (normales Wasser) 	Ablauf Kondensat 
Abgaskamin 	Wrasenabzug Garraum 	Wasseranschluß (enthärtetes Wasser) 	

Die hier aufgeführten Daten sind nicht als bindend zu betrachten. Lainox ALI S.p.A. behält sich das Recht vor, in jedem beliebigen Moment ohne Vorankündigung Änderungen anzubringen

02.04.2014

